



# THE WOMAN TONE

USER MANUAL & SAFETY INSTRUCTIONS

Thank you for purchasing The Woman Tone.  
A time machine to Cream's Farewell Show at the Royal Albert Hall in 1968!

**aclam** 

[www.aclamguitars.com](http://www.aclamguitars.com)

Passatge Can Polític Nº 17, 7è 2a.  
08907 Hospitalet de Llobregat - Barcelona  
GUITAR TRACKS S.L.  
CIF: B19726355

Version 2.0

# Index

Overview	5
Features	7
Specs & material Included	8
Powering Requirements	9
Operating Diagram	10
Controls	11
Internal Controls	14
Suggested Settings and advice to place it into the effect pedal chain	16
Setting up on a pedalboard	20
Troubleshooting	23
Security Instructions	24
Warranty Terms	25
Your own settings	26



# Overview

**The Woman Tone** is our own tribute to **Eric Clapton's** amazing sound during his **Cream** era. An accurate approach to the unique tone he attained with a simple yet effective combination of a P.A.F equipped Gibson and 100W Marshall stacks all the way up.

Cream's last show before their dissolution was The Farewell Concert at The Royal Albert Hall, filmed on November 26, 1968. Clapton was delivering his signature blues licks and amazing riffs with such an amazing tone; impossible not to notice how cool and unique the "Woman Tone" was. That characteristic silky, but at the same time gnarly tone, he attained by rolling off the tone control of his guitar.

"Woman Tone" was one of Clapton's most famous tricks during that period, and after watching the Farewell Concert again, we had renewed interest in re-listening to Cream's records. We ended up paying special attention to songs like "SWLABR", "I Feel Free" or "Sunshine of Your Love"...

Even though the underlying concept could be considered as simple, you would just need a guitar with tone control and an overdriven amp, we realised it wasn't; so, tests with our own vintage gear started.

Rolling off the tone pot and turning it back on while playing was certainly not easy, and what was going on was way more than that: The combination of that specific Gibson SG with humbuckers, potentiometers, and tone capacitors, in conjunction with the Marshall plexi amp would make it incomparable to other tones of the time. We realised how a "Woman Tone" pre-set controlled via footswitch would have made Clapton's life much easier when it came to switching back and forth from standard to the "Woman" tone.

At that point, we were challenged enough to attempt to create a Woman Tone "in-a-box". A pedal with a dedicated footswitch capable of reproducing Clapton's main overdriven sound, keeping it as close to the original as possible, with its same character, emphasising certain frequencies to match Eric's own 1964 Gibson SG, without having to reach any control with the hands; and that

could be used on any guitar & pickup combination.

So, we designed a custom all-analog pickup simulation circuit to reproduce the tonal qualities of a vintage Gibson P.A.F humbucker. We paired it with a Plexi style overdrive with a great dynamic range, so you can achieve the Woman Tone with your own rig.

We fine-tuned the Woman Tone footswitch to slightly increase the gain when engaged, so when you roll off the tone control of the pedal, the saturation does not decrease. It also enhances the low end to make the guitar sound fuller when melodies are played. A joy to play!

As we did with the Dr Robert, we wanted The Woman Tone to pay tribute to Cream both from the inside and outside. We've been lucky enough to get **Marijke Koger**, former member of the incredible **The Fool Dutch Art Collective**, to sign the artwork of The Woman Tone.

Marijke is the artist responsible for the art of **Eric Clapton's iconic 1964 Gibson SG nicknamed "The Fool"**, in honour to the artistic collective Marijke formed with **Simon Posthuma**. Her artwork illustrates the fantasy of

the Woman Tone, depicting a woman in paradise with a very colourful illustration, very representative of the psychedelic movement of that period.

**The result is a pedal with whom you will achieve the legendary Woman Tone by simply pressing a switch. It will not disappoint both Cream fans seeking Clapton's signature sound, and players in search for a classic plexi tone plus a unique feature for solo and rhythm parts!**

# Features

## **ERIC CLAPTON'S CREAM SOUND IN A BOX!:**

We've distilled and bottled in a stompbox the key elements that shaped Eric's rig. Reproduce his unique rhythmic and solo tones, fine-tuned using both live and studio recordings of Cream.

## **CUSTOM ARTWORK BY THE FOOL'S GUITAR ARTIST, MARIJKE KOGER:**

Responsible for the psychedelic decoration of Clapton's Gibson SG nicknamed "The Fool", Marijke accepted creating a unique artistic interpretation of the Woman Tone that exceeded our expectations!

## **CUSTOM HUMBucker PICKUP SIMULATION CIRCUIT AND TONE CONTROL:**

A pickup simulation circuit emulating the tonal characteristics of a P.A.F style pickup has been incorporated to reproduce the "Woman Tone". With its buffered input, the guitar signal won't be affected. Use compressors, fuzzes or whatever effect you want in front of the Woman Tone, and it will retain its tonal characteristics.

## **TOUCH SENSITIVE PLEXI-INSPIRED OVERDRIVE USING DISCRETE COMPONENTS:**

Inspired by Clapton's 100W full stacks it results in a powerful overdrive with a great British character! Designed having blues-rock in mind, it will perfectly suit any guitar player seeking a vintage tone!

## **TRUE BYPASS RELAY SWITCHING:**

Our soft touch switch activated relay switching is a much more reliable bypass system than the traditional 3PDT footswitches. Like all our pedals, it is true bypass to ensure signal integrity.

## **SMART TRACK® FASTENING SYSTEM:**

Custom enclosure designed to perfectly match our Smart Track® pedalboards. Safely lock the stompbox into one of our pedalboards by using the side thumb screws or use velcro for the rest of the pedalboards in the market.

# Specs & Material included

## THE WOMAN TONE REF:

AP0040

## DIMENSIONS:

13,7 x 8,8 x 5,5cm (5.4" x 3.4" x 2.2") with knobs

## WEIGHT:

424g (0.93 lb)

## BYPASS:

Relay True Bypass

## POWER REQUIREMENTS:

9V DC Center Negative 40mA minimum

## CURRENT DRAW:

≈10mA

## DECLARATION OF CONFORMITY:

This product complies with the requirements of



## MADE IN SPAIN

## MATERIAL INCLUDED

1 x The Woman Tone pedal

1 x Anti-sliding rubber pad

1 x Velcro® pad

# Power requirements

## POWER SUPPLY

This unit must be powered with a 9VDC negative tip power supply with the standard Boss type 2.1mm connector.

Current supply should be a minimum of 40 mA just to leave a safety margin for the DC adapter.

Make sure you use a good quality power supply and avoid using generic SMPS type adapters which can induce high pitched noise to the audio.



### CAUTION:

Please note this pedal **MUST** not be powered with any voltage above 9VDC. Powering it up with a 12V or 18V power supply will damage its circuit and immediately void the warranty.

# Operating Diagram

GUITAR AMP INPUT

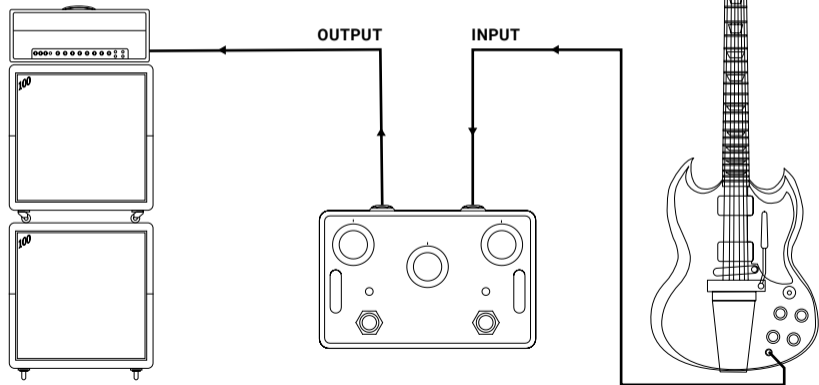

# Controls

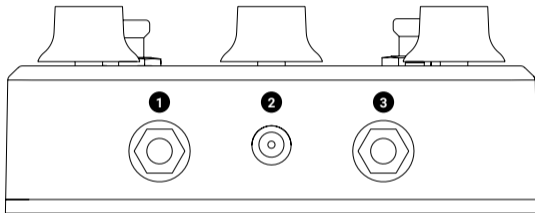

**1** INPUT JACK

**2** POWER JACK

**3** OUTPUT JACK

- 4 **BYPASS SWITCH:** Engages the unit allowing the signal to flow through the Woman Tone circuit. It also lights up the LED above it.
- 5 **GAIN:** Sets the amount of overdrive. Turn it clockwise all the way up to get a roaring plexi saturation!
- 6 **WOMAN MODE SWITCH:** Activates the Woman Tone knob. It also lights up the led above it.
- 7 **WOMAN MODE KNOB TONE:** This knob has the same behaviour as the tone control found on most electric guitars. By turning it counterclockwise, it reduces the treble content of the guitar signal making it sound darker and silky.  
The trick inside the Woman Tone is our custom pickup simulation circuit that reproduces the tonal characteristics of a classic humbucker pickup. This is the key to reproduce the iconic sound that was Clapton's trademark during the Cream days!

Aside from enabling the knob, this mode boosts the gain in order to compensate for the slight volume drop caused by the tone control rolled off so if you use this mode with the Woman Tone Knob fully clockwise you can use the pedal as a dual stage overdrive!

- 8 **VOLUME:** Controls the overall volume of the unit!

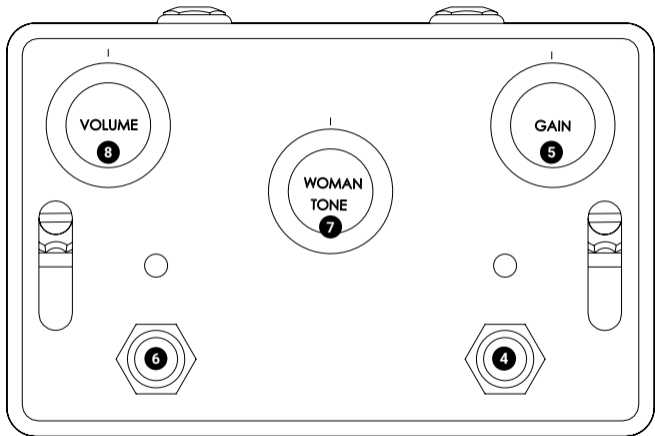

# Internal Controls

## HOW TO ACCESS:

- ① Loosen the side thumb screws and disassemble the Smart Track<sup>®</sup> system of both sides of the pedal.

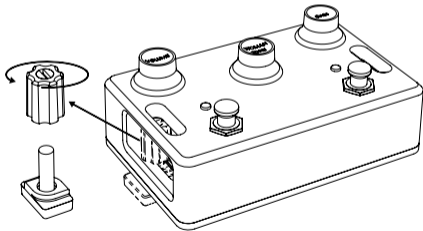

- ② Remove the screws of the baseplate to access the inside of the pedal.

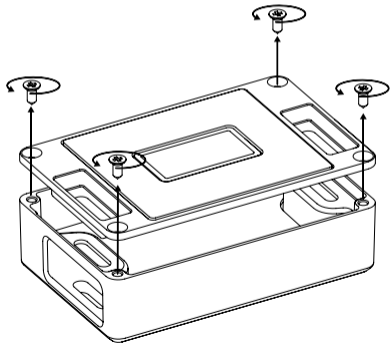

**9 INTERNAL DIP SWITCH (DARKER WOMAN TONE):**

When we designed the Woman Tone, we focused on getting the closest to Clapton's live and studio sound but at the same time to make the pedal versatile and even with few controls, to suit different tastes.

Because the pickup simulation circuit behaves the same as a real pickup, by changing the tone capacitor value we can change the response of the Woman Tone mode and make it darker or brighter. And this is exactly what the dip switch does!

For the ones that like a mellower and darker Woman Tone, all that needs to be done is to open the pedal and using a small flat screwdriver slide the dip switch to the ON position. We encourage you to experiment and find which mode is better to your taste!

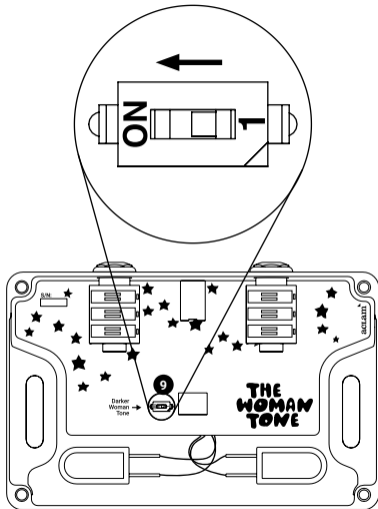

# Suggested Settings and advice to place it into the effect pedal chain

Thanks to the buffered pickup simulation circuit of the Woman Tone, it doesn't matter where you put it on the effects chain, it will retain its tonal characteristics and behave exactly the same when the Woman Tone knob is active. Although as it happens when you stack saturation pedals, the last one has a higher impact on the final timbre of your sound.

That being said, there's no written rules on which pedal should be placed first after the guitar or if overdrives should be placed before modulations but here's our opinion on how to get the best results with the Woman Tone. If you want to use the Woman Tone for solos and lead parts we recommend you to put it before your other saturation pedals.

On the other hand, if your intention is to have the pedal on most of the time to be the foundation of your overdriven sound, we think it is better to put it the last one in your overdrive chain.

All the examples shown below are being fine-tuned with the guitar plugged into the Woman Tone and straight to the amp, no other pedals involved.



LISTEN TO WOMAN TONE  
SUGGESTED SETTINGS



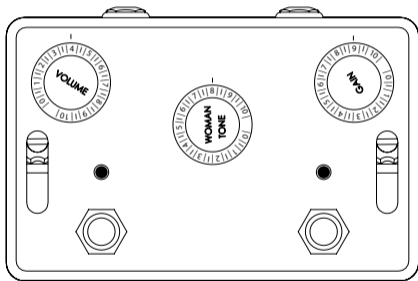
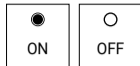

**SUNSHINE OF YOUR LOVE - CREAM (MAIN RIFF)**  
*Telecaster - Neck Pickup*

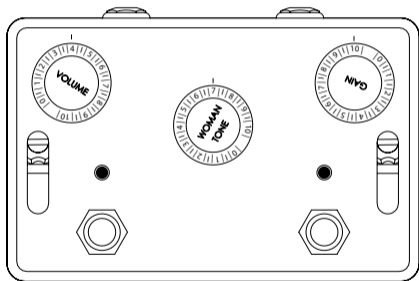

**SUNSHINE OF YOUR LOVE - CREAM (SOLO)**  
*Telecaster - Neck Pickup*

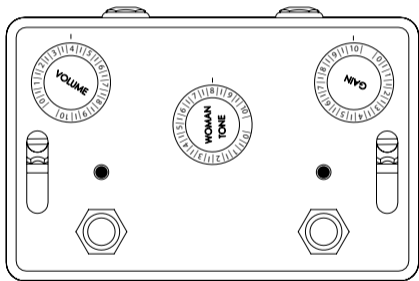

**I FEEL FREE - CREAM (SOLO)**  
*Gibson 335 - Neck Pickup*

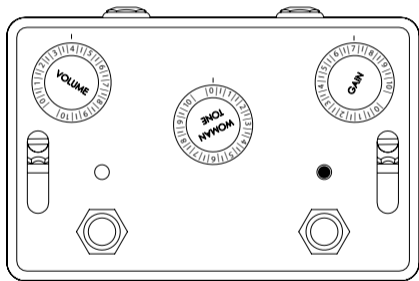

**I FEEL FREE - CREAM (RHYTHM)**  
*Gibson 335 - Bridge Pickup*

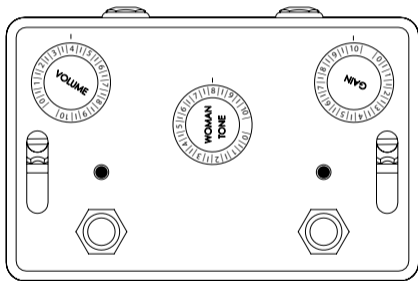

**AMERICAN WOMAN - THE GUESS WHO (SOLO)**

*Gibson 335 - Neck Pickup*

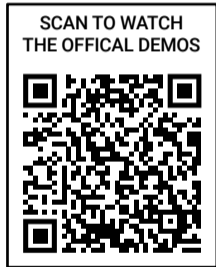
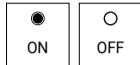

# Setting up on a pedalboard

All our effect pedals use a custom light aluminum enclosure specially designed to fit our Smart Track® pedalboards. We incorporated a proprietary locking system which allows the user to fasten the pedal without the need of using the typical hook and loop method. This custom fastening system follows the same philosophy behind the Smart Track® fasteners but integrated in the enclosure reducing the space occupied by each pedal.

That translates into more pedal density for the same space, and who doesn't want that?

We strongly recommend you to take a look at our line of pedalboards, which are the best complement to our pedals!

## HOW TO MOUNT IT ON A SMART TRACK® PEDALBOARD:

- 1 Add the anti-sliding rubber pad at the bottom of your pedal, specially shaped for this unit.  
⚠ Surface must be clean and dry before applying adhesive pad.

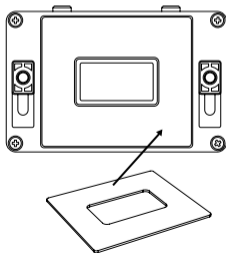

- 2 Loosen the 2 thumb screws to unlock the bottom pieces out of the pedal.
- 3 Place the pedal, inserting the bottom pieces inside the grooves.

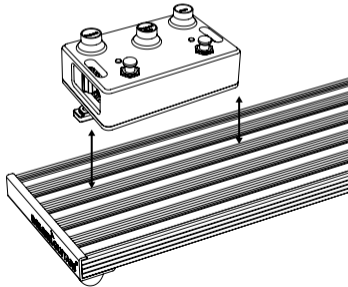

- 4 Move the pedal to its final position.

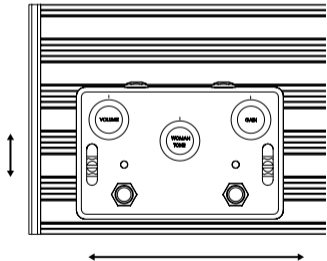

- 5 Tighten the two thumb screws with your hands or with a screwdriver.

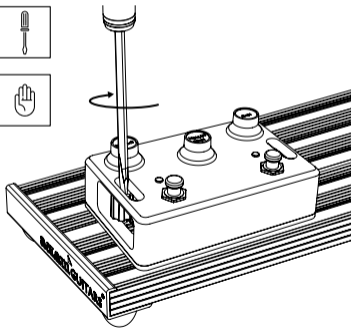

### USING OTHER PEDALBOARDS:

**Hook and Loop:** Take the included super strong Velcro® pad and stick it on the base plate. Again, make sure the base is clean of dirt and dust.

**Pre-drilled pedalboard:** Fix it with a bolt and a nut you could find at any hardware store or instead of passing the zip tie over the pedal you can take advantage of the Smart Track® enclosure and put the zip ties over the holes.

**DIY woodboard:** You can screw the pedal directly with wood bolts through the enclosure side holes.

**No board:** If you use the pedals standalone make sure you place the included anti-sliding rubber pad on the baseplate.

# Troubleshooting

## **SIGNAL PASSES THROUGH IN BYPASS BUT NOT WHEN ENGAGED:**

Make sure you've connected the input and output jacks correctly.

## **PEDAL DOES NOT WORK WITH THE POWER SUPPLY:**

Take a look at your power supply output voltage and polarity. Make sure it's 9V DC negative tip and can provide enough current to run the pedal safely.

Most modern power supplies have an output of 100mA or more and that is more than enough for the Woman Tone.

## **PEDAL SOUNDS DISTORTED AT REALLY LOW SETTINGS:**

The Woman Tone is a really dynamic pedal. Different types of guitars and pickups will make it saturate in different regions of the Gain knob. That is a totally correct response from the unit.

Make sure there's not any pedal before the Woman Tone increasing too much the guitar's signal output, like boosters, preamps compressors and other overdrive pedals.

## **LEDS FLASHING FAST AND UNIT DOESN'T ENGAGE:**

Power supply is 12V or higher and may cause damage to the unit.

## **BYPASS LED LIGHT UP IN RED AND UNIT DOESN'T ENGAGE:**

Reverse polarity power supply.

# Security Instructions

- Read these instructions carefully.
- Keep them for future reference.
- Heed all warnings.
- Aclam Guitars shall not be held liable for any damage to persons or property caused by incorrect operation or installation.
- Use the product in accordance with the assembly instructions. Do not modify or operate the product incorrectly.
- Incorrect installation could result in serious damage to persons and property.
- Open the package and check that the assembly instructions and all the parts of the product are there. Check that none of the parts are defective.
- Keep out of reach of children. This product contains small parts that represent a choking hazard if swallowed.
- If you do not understand these safety instructions, or if you have any queries regarding the safety of the installation, please contact us at: [support@aclam.cat](mailto:support@aclam.cat)

# Warranty Terms

This product is covered by a two-year warranty from the purchase date, under the conditions and supporting evidence regulated by current Spanish Legislation.

The product warranty will only be applicable by presenting the proof of purchase (which is the invoice or the receipt) and serial number.

A product is covered under warranty if it presents lack of conformity because it does not correspond to the specified product characteristics, is defective which prevents its normal use according to its purpose, or does not function as described. The purchaser has the right to have the article repaired or replaced (either the product or the faulty component, at the discretion of the manufacturer.)

The warranty is not transferable and won't cover the following issues:

- Attempts of modifications or repairs by an unauthorized service center.

- Unsuitable use
- Incorrect storage
- Explosions or burns caused by incorrect power supplies.
- Other causes not attributable to the manufacturer.

To make a claim, the purchaser must return the product to the store where it was purchased within one month from discovering the fault, and report the nature of the problem, the time and the circumstances under which it occurred.

If the product was purchased through our website, the purchaser must refer to [www.aclamguitars.com](http://www.aclamguitars.com) and complete an RMA (Return to Manufacturer Authorization) form before returning the unit.

We strongly recommend looking at the "Troubleshooting" section of the manual before panicking!!

# Your own settings

Use this space to save your best setting samples and share them on your social media using **#aclamguitars**

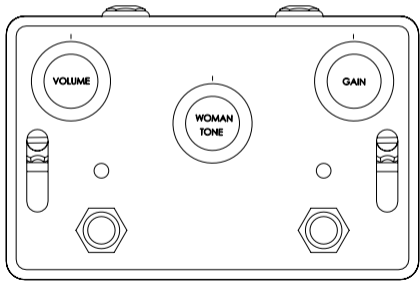
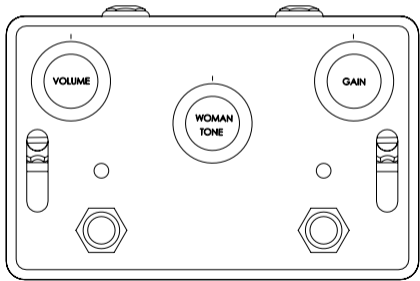

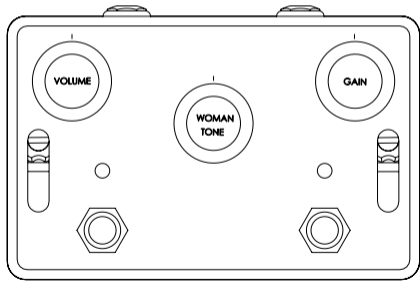
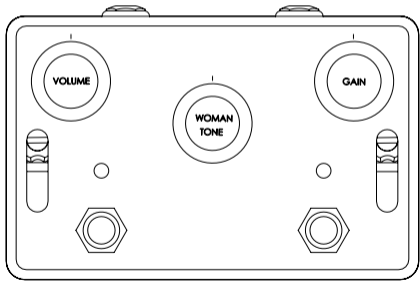



aclam

[www.aclamguitars.com](http://www.aclamguitars.com)